

Passenger vehicle trailer range

# Single-axle trailers

Flatbed trailer/wheels-in trailer

Small but strong trailers by Humbaaur



MAKES IT HAPPEN



# Experience it for yourself



Follow **HUMBAUR!**

**The quality trailer specialist.**

Alois Huber, private individual, Sonthofen, Germany

Our rationale makes it easy for you to become a staunch supporter of Humbaaur's high-quality products.

#### **35 years of experience**

We have been one of the leading manufacturers of passenger vehicle trailers for three decades. Over 950,000 trailers have left our premises since our company was founded. Nowadays, we produce around 52,000 units per year. And our wealth of experience is reflected in each of our trailers.

#### **High quality**

Robust and long-lasting — that's what a trailer needs to be. We use outstanding components and first-rate processing to achieve this goal. Before we deliver each trailer, we put it through its paces.

#### **A wide range of transportation solutions**

Our offering covers a very wide range of applications. Whether you are looking for a trailer in a private or commercial capacity, we can provide you with the appropriate model. You can choose between a total permissible weight from 750 kg up to 50 t.

#### **Wide range of accessories**

Do you have very specific demands when it comes to your trailer? Thanks to a number of matching accessories, you can add to the comprehensive standard features to meet your requirements accordingly.



**MAKES IT HAPPEN**

#### **Committed customer service**

If your trailer weighs up to 3.5 t, your specialist dealer in your area will be happy to help. Owners of trailers weighing upwards of 5 t total weight are able to take advantage of our direct service. Whether you need a spare part or have a question about how to use your trailer — we, together with your on-site dealer, will be happy to help.

#### **High-quality components**

Quality is reflected in the detail — that's why Humbaaur only uses high-quality vehicle components that have been produced by reputable manufacturers. We continuously share our experiences with our suppliers. In this way we are able to continuously improve our products.

## Table of contents

Experience it for yourself .....	2
Exactly what building contractors and passionate gardeners need .....	4
<b>Flatbed trailers</b>	
Steely .....	6
Steely (folding drawbar) .....	10
Startrailer .....	12
Startrailer (folding drawbar) .....	18
HA (tilting).....	20
HA Allrounder.....	26
HA Multi.....	28
<b>Wheels-in trailers</b>	
HU .....	30
HN .....	34
Optional accessories.....	38
About Humbaur.....	42



# Exactly what **building contractors** and **passionate gardeners** need

## The 1000 series

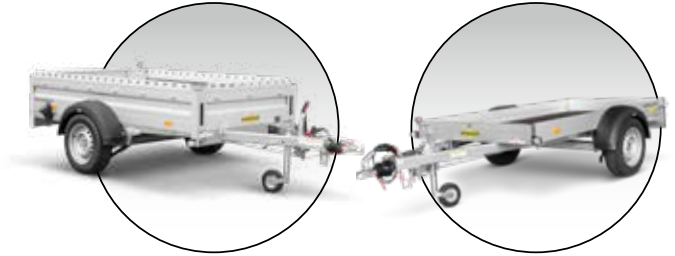

**Steely flatbed trailer**

With its non-slip, water-resistant wooden floor and robust construction, the Steely flatbed trailer makes for a helpful companion both in the garden and on the construction site. Elegant toggle-type fasteners keep the tailgate securely closed. Do you need a raised or flat tarpaulin? The fastening buttons are pre-fitted so that the trailer can be retrofitted with a cover at any time.



**Startrailer flatbed trailer**

Do you have to transport garden waste, small bulk waste or larger goods? Then the Startrailer flatbed trailer is just what you're looking for. It's very light and versatile, with an attractive appearance. The retractable tie-down hoops in the side plates are another practical feature.



**HA flatbed trailer**

Ideal for almost any task. The large selection of accessories allows you to equip the HA flatbed trailer for a wide range of applications. It can transport your motorcycles, bicycles, garden equipment and much more. The load can be lashed down using the tie-down hoops recessed in the aluminium side walls to prevent it from sliding around.



### **Tilting HA flatbed trailer**

It is easier to transport loads such as garden equipment and motorcycles if the trailer can be tilted. For applications of this kind and similar, we offer a variant of the HA flatbed trailer that has a tilting body. A shock absorber simplifies the tilting process. Reinforcements, such as additional hinges on the tailgate, make the trailer particularly stable.



### **HU wheels-in trailer**

The HU wheels-in trailer is designed with durability and quality in mind. All of the vital metal components are hot-dip galvanised. You can fold down the side plates, or remove them completely, to make loading and unloading particularly easy. Loads can be easily fixed down using the lashing rings. The low loading height comes in useful during day-to-day applications.



### **HN wheels-in trailer**

Practical and well-designed: With the side plates folded down, you can easily load your goods onto the HN wheels-in trailer by using a forklift truck. Its low loading height makes handling easier for you. The lashing rings on our trailers can withstand tensile forces of 400 kg, allowing you to transport even heavy loads safely (tested by DEKRA).



# Steely flatbed trailer

A helpful companion both in the garden and on the construction site

- 1 V drawbar, **hot-dip galvanised**
- 2 7 pin plug
- 3 **Base plate** 9 mm thick
- 4 **Side plates** made of hot-dip galvanised, angled **sheet steel**
- 5 **Tailgate** with toggle-type fasteners
- 6 **Four tie rings** on the inner side of the trailer's side plates
- 7 Pre-assembled **fastening buttons** on the side plates **for attaching tarpaulins**
- 8 Humbaur **multifunctional lighting** integrated in the underrun protection
- 9 **Stanchions** for slotting in optional equipment



## 1000 Series

<b>Model</b>	<b>Steely</b>
<b>Overall dimension in mm</b>	2960 x 1545 x 805
<b>Internal dimension in mm</b>	2050 x 1095 x 300
<b>Total permissible weight in kg</b>	750
<b>Load capacity in kg</b>	630
<b>Load height in mm</b>	495
<b>Tyres in inches</b>	13

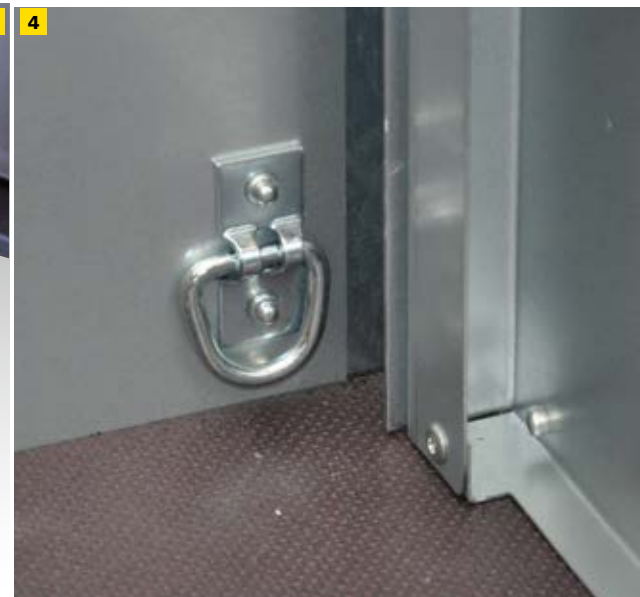
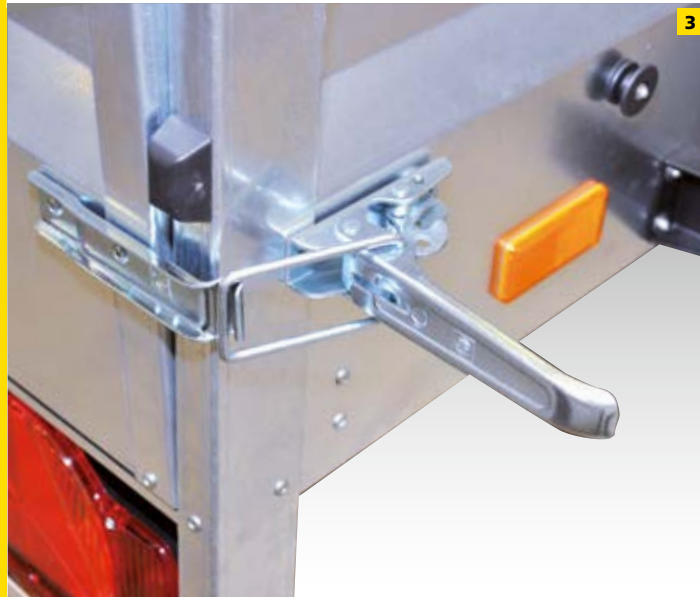

- 1 Hot-dip galvanised V drawbar with transverse strut
- 2 300-mm-tall side plate extension (optional)
- 3 Toggle-type fasteners on the tailgate
- 4 Four tie rings attached to the side walls

Subject to change without notice. All dimensions are approximate values and refer to the standard vehicle without accessories.



# Steely flatbed trailer

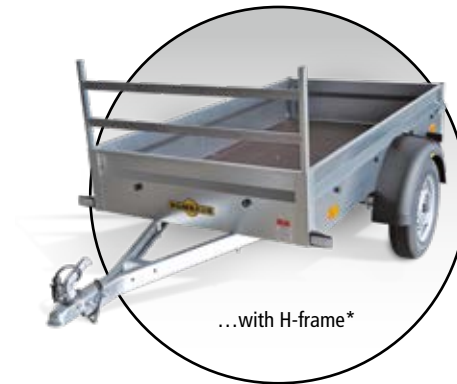

## \*Accessories (optional):

- 300-mm side plate extension
- H-frame
- Flat tarpaulin, grey
- Tarpaulin and frame, load height 1000 mm, grey
- Two prop stands, loose
- Covering net
- 7-pin to 13-pin adapter
- Spare wheel
- Jockey wheel with mounting parts



## 1000 Series

<b>Model</b>	<b>Steely DK</b>
<b>Overall dimension in mm</b>	2960 x 1545 x 805
<b>Internal dimension in mm</b>	2050 x 1095 x 300
<b>Total permissible weight in kg</b>	750
<b>Load capacity in kg</b>	604
<b>Load height in mm</b>	495
<b>Tyres in inches</b>	13



1 2  
3 4

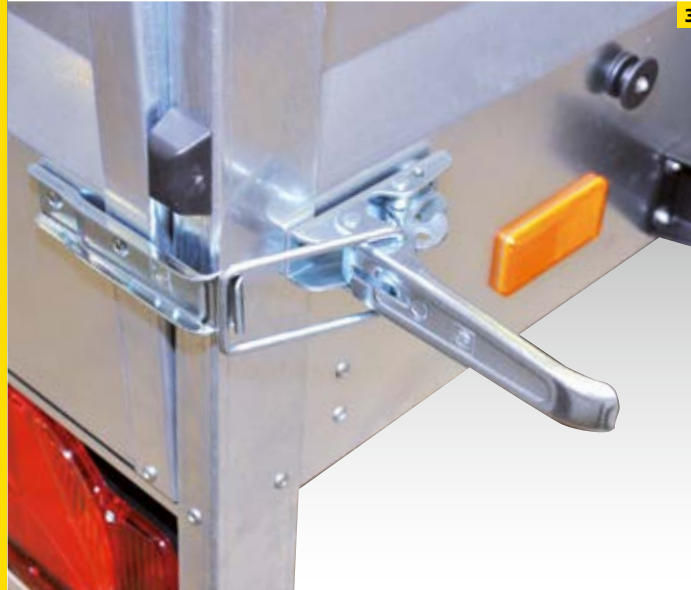

- 1 Hot-dip galvanised V drawbar with transverse strut
- 2 300-mm-tall side plate extension (optional)
- 3 Toggle-type fasteners on the tailgate
- 4 Four tie rings attached to the side walls

Subject to change without notice. All dimensions are approximate values and refer to the standard vehicle without accessories.

# Steely flatbed trailer



Positioned vertically



## \*Accessories (optional):

- 300-mm side plate extension
- H-frame
- Flat tarpaulin, grey
- Tarpaulin and frame, load height 1000 mm, grey
- Two prop stands, loose
- Covering net
- 7-pin to 13-pin adapter
- Spare wheel
- Jockey wheel with mounting parts



# Startrailer flatbed trailer

This trailer helps with almost any application

- 1 V drawbar, **hot-dip galvanised**
- 2 13-pin plug
- 3 Base plate **12 mm thick**
- 4 **Side plates** made of an **anodised, double-walled aluminium profile**
- 5 **Tailgate** with recessed fasteners
- 6 **Lashing rings integrated in the side plates**; each can withstand a tensile force of 400 kg, as tested by DEKRA
- 7 **Pre-assembled fastening buttons** on the side plates for **attaching tarpaulins**
- 8 Humbaur **multifunctional lighting** integrated in the underrun protection
- 9 **Stanchions** for slotting in optional equipment

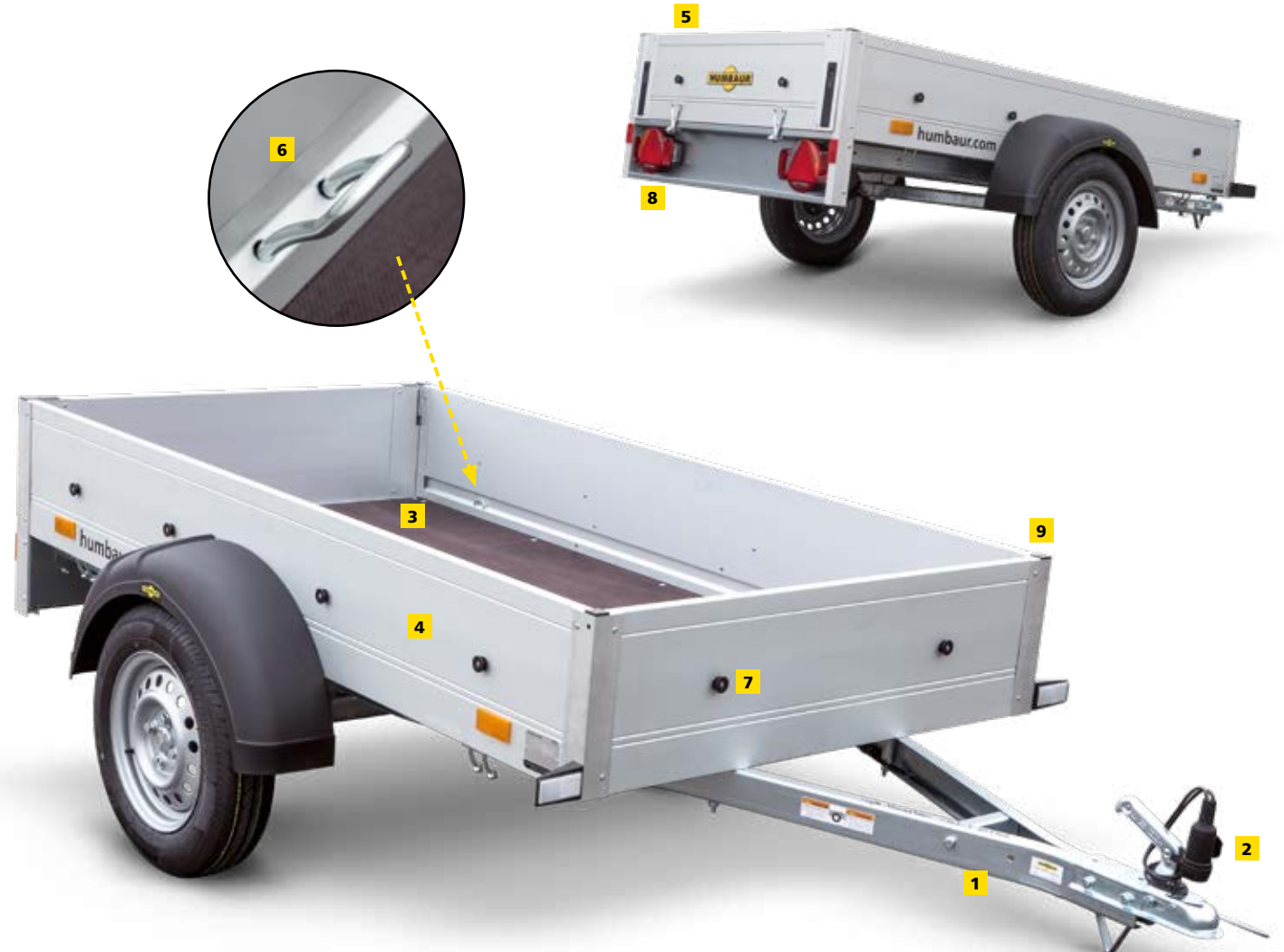

## 1000 Series

<b>Model</b>	<b>H 752010</b>
<b>Overall dimension in mm</b>	2970 x 1537 x 800
<b>Internal dimension in mm</b>	2050 x 1095 x 300
<b>Total permissible weight in kg</b>	750
<b>Load capacity in kg</b>	614
<b>Load height in mm</b>	500
<b>Tyres in inches</b>	13



- 1 Recessed lashing eyes
- 2 Side plates made of an anodised, double-walled aluminium profile
- 3 Hot-dip galvanised V drawbar

Subject to change without notice. All dimensions are approximate values and refer to the standard vehicle without accessories.

# Startrailer flatbed trailer



With flat tarpaulin



With side railing



With side plate extension



With tarpaulin and frame

## \*Accessories (optional):

- 300-mm side plate extension
- 500-mm H-frame, welded
- Railing attachment on the sides
- Wood/aluminium cover, interior height 185 mm
- Railing on wood/aluminium cover
- Two crossbars for bicycle stand rails
- One bicycle stand rail with bracket (can be locked)
- Covering net
- Flat tarpaulin, grey
- Tarpaulin (blue) and frame, 1000 mm
- Spare wheel
- Spare wheel bracket
- Jockey wheel with mounting parts
- 7-pin to 13-pin adapter
- Two prop stands

## 1000 Series

<b>Model</b>	<b>H 752513</b>
<b>Overall dimension in mm</b>	3585 x 1760 x 800
<b>Internal dimension in mm</b>	2510 x 1310 x 300
<b>Total permissible weight in kg</b>	750
<b>Load capacity in kg</b>	602
<b>Load height in mm</b>	500
<b>Tyres in inches</b>	13

<b>Model</b>	<b>H 132513</b>
<b>Overall dimension in mm</b>	3765 x 1800 x 830
<b>Internal dimension in mm</b>	2510 x 1310 x 300
<b>Total permissible weight in kg</b>	1300
<b>Load capacity in kg</b>	1078
<b>Load height in mm</b>	530
<b>Tyres in inches</b>	14

- 1 Hot-dip galvanised V drawbar, 13-pin plug
- 2 Tarpaulin (grey) and frame, load height 1500 mm
- 3 H 132513 with jockey wheel

Subject to change without notice. All dimensions are approximate values and refer to the standard vehicle without accessories.



1



...with tarpaulin and frame\*

2



H 132513 with jockey wheel

3





# Startrailer flatbed trailer

This trailer helps with almost any application

- 1** V drawbar, **hot-dip galvanised**
- 2** 13-pin plug
- 3** Base plate **15 mm thick**
- 4** **Side plates** made of an **anodised, double-walled aluminium profile**
- 5** **Tailgate** with sturdy fasteners
- 6** **Lashing rings integrated in the side plates;** each can withstand a tensile force of 400 kg, as tested by DEKRA
- 7** **Pre-assembled fastening buttons** on the side plates for **attaching tarpaulins**
- 8** Humbaur **multifunctional lighting** integrated in the underrun protection
- 9** **Stanchions** for slotting in optional equipment

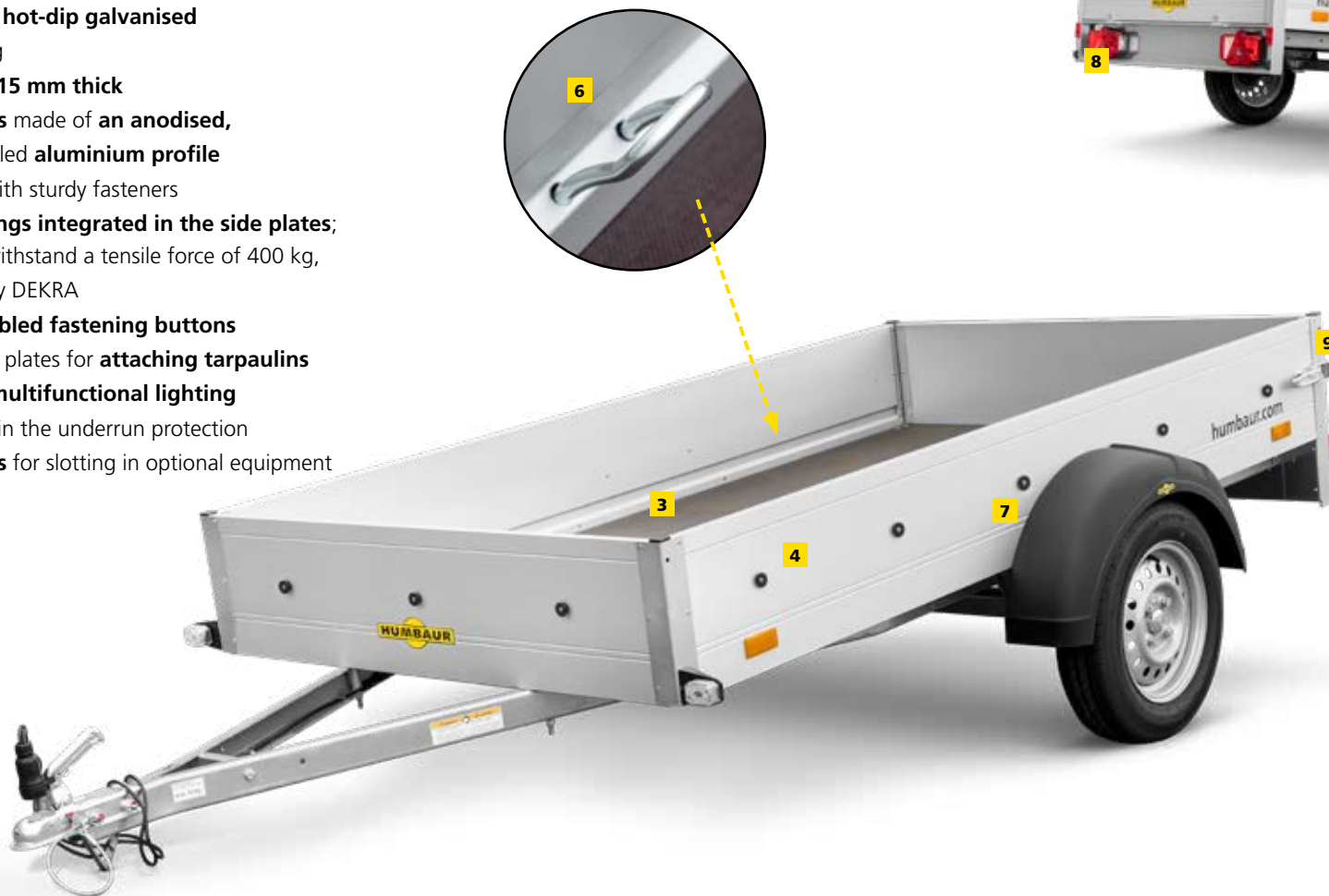

## \*Accessories (optional):

- 300-mm side plate extension
- 500-mm H-frame, welded
- Railing attachment on the sides
- Wood/aluminium cover, interior height 185 mm
- Railing on wood/aluminium cover
- Two crossbars for bicycle stand rails
- One bicycle stand rail with bracket (can be locked)
- Covering net
- Flat tarpaulin, grey
- Tarpaulin (grey) and frame, 1500 mm
- Spare wheel
- Spare wheel bracket
- Jockey wheel with mounting parts
- 7-pin to 13-pin adapter
- Two prop stands

## 1000 Series

<b>Model</b>	<b>Startrailer DK</b>
<b>Overall dimension in mm</b>	2965 x 1545 x 805
<b>Internal dimension in mm</b>	2050 x 1095 x 300
<b>Total permissible weight in kg</b>	750
<b>Load capacity in kg</b>	604
<b>Load height in mm</b>	495
<b>Tyres in inches</b>	13



- 1 Hot-dip galvanised V drawbar, 13-pin plug
- 2 Tarpaulin (grey) and frame, load height 1000 mm

Subject to change without notice. All dimensions are approximate values and refer to the standard vehicle without accessories.

...with tarpaulin and frame\*

# Startrailer flatbed trailer



Positioned vertically



## \*Accessories (optional):

- 300-mm side plate extension
- 500-mm H-frame, welded
- Railing attachment on the sides
- Wood/aluminium cover, interior height 185 mm
- Railing on wood/aluminium cover
- Two crossbars for bicycle stand rails
- One bicycle stand rail with bracket (can be locked)
- Covering net
- Flat tarpaulin, grey
- Tarpaulin (grey) and frame, 1000 mm
- Spare wheel
- Spare wheel bracket
- Jockey wheel with mounting parts
- 7-pin to 13-pin adapter
- Two prop stands



# HA flatbed trailer

The universal workhorse:  
Versatile and robust



- 1** V drawbar, **hot-dip galvanised**
- 2** **13-pin plug** and **reversing light**
- 3** **Base plate** 15 mm thick
- 4** **Side plates** made of **anodised**, double-walled **aluminium profile**
- 5** **Tailgate** with recessed fasteners
- 6** **Front gate** with recessed fasteners (optional)
- 7** **Lashing rings** (4x for body lengths up to 2050 mm/6x for body lengths over 2510 mm) **integrated in the side plates**; each lashing ring can withstand a tensile force of 400 kg, as tested by DEKRA
- 8** **With the tilting HA only: Bridge** with **shock absorber** for tilting; **18° tilt angle at the rear**; **reinforced tailgate** and **reinforced underrun protection on the HA 132513**
- 9** Humbaur **multifunctional lighting** integrated in the underrun protection
- 10** **Stanchions** for slotting in optional equipment
- 11** **Ramp wall** that can be folded down at the rear, only on the **HA 132513, aluminium with lattice ramp wall**



# 1000 series

Permissible gross weight in kg	MODEL	Overall dimension in mm	Internal dimensions in mm	Load capacity in kg	Load height in mm	Tyres in inches	braked
750	HA 751611	2680 x 1548 x 870	1650 x 1100 x 350	625	510	13	
750	HA 751611 G	2815 x 1550 x 870	1650 x 1100 x 350	608	510	13	✓
750	HA 751611-5	2680 x 1548 x 1020	1650 x 1100 x 500	605	510	13	
750	HA 751611-5 G	2815 x 1550 x 1020	1650 x 1100 x 500	588	510	13	✓
750	HA 752111	3025 x 1548 x 870	2050 x 1100 x 350	610	510	13	
750	HA 752111-5	3025 x 1548 x 1020	2050 x 1100 x 500	598	510	13	
750	HA 752113	3035 x 1760 x 870	2050 x 1310 x 350	602	510	13	
750	HA 752113-5	3035 x 1760 x 1020	2050 x 1310 x 500	589	510	13	
750	HA 752513	3580 x 1760 x 865	2510 x 1310 x 350	581	510	13	
750	HA 752513 FS	3580 x 1760 x 865	2510 x 1310 x 350	585	510	13	
750	HA 752513-5	3580 x 1760 x 1015	2510 x 1310 x 500	565	510	13	
750	HA 752513, tilting	3580 x 1760 x 865	2510 x 1310 x 350	577	510	13	



HA 752111



HA 132513

Subject to change without notice. All dimensions are approximate values and refer to the standard vehicle without accessories.

# HA flatbed trailer

Permissible gross weight in kg	MODEL	Overall dimension in mm	Internal dimensions in mm	Load capacity in kg	Load height in mm	Tyres in inches	braked
1000	HA 102111	3215 x 1550 x 905	2050 x 1100 x 350	822	525	13	✓
1000	HA 102111-5	3215 x 1550 x 1055	2050 x 1100 x 500	810	525	13	✓
1000	HA 102113	3215 x 1770 x 890	2050 x 1310 x 350	801	530	13	✓
1000	HA 102113-5	3215 x 1770 x 1040	2050 x 1310 x 500	788	530	13	✓
1300	HA 132513	3760 x 1810 x 905	2510 x 1310 x 350	1058	530	14	✓
1300	HA 132513 FS	3780 x 1810 x 905	2510 x 1310 x 350	1063	530	14	✓
1300	HA 132513-5	3760 x 1810 x 1055	2510 x 1310 x 500	1043	530	14	✓
1300	HA 132513, tilting	3795 x 1800 x 915	2510 x 1310 x 350	1046	565	14	✓
1300	HA 132513, aluminium with lattice ramp wall	3850 x 1810 x 1525	2510 x 1310 x 350	1008	530	14	✓
1500	HA 152513	3760 x 1810 x 875	2510 x 1310 x 350	1248	525	14	✓
1500	HA 152513 FS	3760 x 1810 x 875	2510 x 1310 x 350	1253	525	14	✓
1500	HA 153015	4320 x 2004 x 940	3030 x 1500 x 350	1209	590	14	✓



HA 132513-5



HA 752513, tilting

Subject to change without notice. All dimensions are approximate values and refer to the standard vehicle without accessories.



1



2

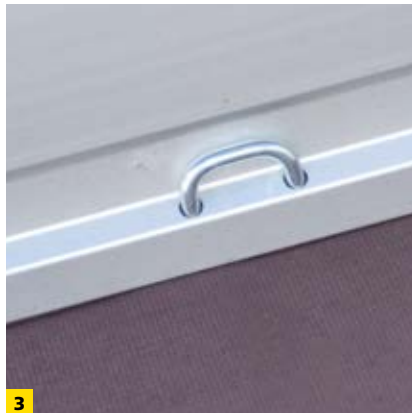

3



5



6



4

- 1 Tilting body structure (on the tilting HA) with shock absorber support
- 2 Hot-dip galvanised drawbar
- 3 Lashing rings (4x or 6x) integrated in the side plates, as standard with 350-mm side plates
- 4 Driving onto the tilting HA
- 5 Front side lights
- 6 Tailgate with recessed fasteners

With reinforced tailgate and reinforced underrun protection on the tilting HA 132513

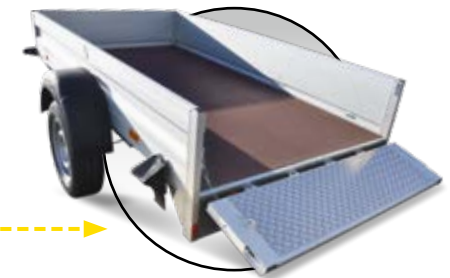



# HA flatbed trailer



...with tarpaulin and frame\*



...with wood/aluminium cover, railing and bicycle stand rail\*



...with steel lattice extension\*

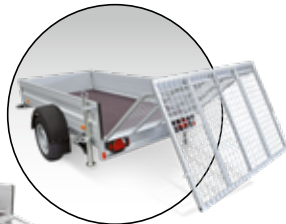

...with folding lattice ramp wall\*



18°

## \*Accessories (optional):

- Spare wheel
- Spare wheel bracket
- Jockey wheel with mounting parts
- Two prop stands
- Loose wheel shock absorbers without 100 km/h confirmation
- Wheel shock absorbers (mounted) with 100 km/h approval
- 7-pin to 13-pin adapter
- Front gate
- Steel lattice extension 620 mm
- 500-mm H-frame, welded
- Railing on the sides
- Aluminium side plate extension
- Wood/aluminium cover with base side plate, pre-assembled, interior height 185 mm
- Railing on wood/aluminium cover
- Two crossbars for bicycle stand rails, width 1100 mm
- One bicycle stand rail with bracket (can be locked)
- Flat tarpaulin
- Tarpaulin and frame, load height 1300 mm/1600 mm/1800 mm
- Long drawbar (version depends on model, unavailable for some models)
- Folding lattice ramp wall

Ideal for any task —  
with that little extra touch

- 1 V drawbar, **hot-dip galvanised**
- 2 **13-pin plug** and **reversing light**
- 3 **Base plate** 15 mm thick
- 4 **Side plates** made of **anodised**, double-walled **aluminium profile**
- 5 **Gates** with recessed fasteners
- 6 **Six tie-down hoops integrated in the side plates**, each hoop can withstand a tensile force of 400 kg, as tested by DEKRA
- 7 Humbaur **multifunctional lighting**
- 8 **Stanchions** for slotting in optional equipment
- 9 Includes **shock absorbers, loading ramps, stand rail, railing, flat tarpaulin, prop stand and loose toolbox**



# HA Allrounder flatbed trailer

## \*Accessories (optional):

- Steel spare wheel
- Spare wheel bracket



1



2

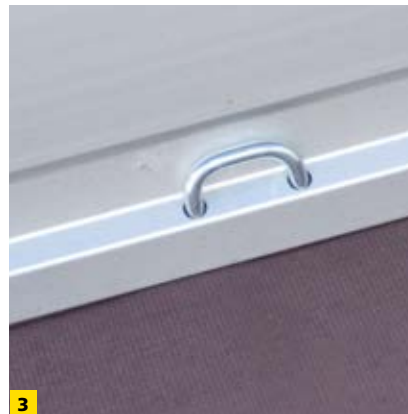

3



4

## 1000 Series

<b>Model</b>	<b>HA 132513 Allrounder</b>
<b>Overall dimension in mm</b>	3760 x 1810 x 955
<b>Internal dimension in mm</b>	2510 x 1310 x 400
<b>Total permissible weight in kg</b>	1300
<b>Load capacity in kg</b>	1011
<b>Load height in mm</b>	530
<b>Tyres in inches</b>	14

- 1 Tailgate with recessed fasteners
- 2 Loose toolbox
- 3 Integrated lashing rings (6x) in the side plates as standard
- 4 Aluminium loading ramps

Subject to change without notice. All dimensions are approximate values and refer to the standard vehicle without accessories.

## A multi-purpose trailer — always ready to go

- 1 Galvanised V drawbar
- 2 13-pin plug and reversing light
- 3 Base plate 15 mm thick
- 4 Side plates made of an anodised, double-walled aluminium profile
- 5 Tailgate with toggle-type fasteners
- 6 Fixed front wall
- 7 6 Lashing rings integrated in the side plates; each hoop can withstand a tensile force of 400 kg, as tested by DEKRA
- 8 Plank shaft integrated in the underrun protection
- 9 Humbaar multifunctional lighting
- 10 Stanchions for slotting in optional equipment



# HA Multi flatbed trailer

## \*Accessories (optional):

- Standard jockey wheel with mounting parts (standard equipment on the HA 132513 Multi RSD)
- 300-mm side plate extension
- Aluminium cover
- Flat tarpaulin
- Motorcycle stand rail
- Aluminium loading ramps



## 1000 Series

<b>Model</b>	<b>HA 752513 Multi</b>
<b>Overall dimension in mm</b>	3585 x 1760 x 650
<b>Internal dimension in mm</b>	2510 x 1310 x 150
<b>Total permissible weight in kg</b>	750
<b>Load capacity in kg</b>	602
<b>Load height in mm</b>	500
<b>Tyres in inches</b>	13

<b>Model</b>	<b>HA 132513 Multi RSD</b>
<b>Overall dimension in mm</b>	3765 x 1800 x 755
<b>Internal dimension in mm</b>	2510 x 1310 x 150
<b>Total permissible weight in kg</b>	1300
<b>Load capacity in kg</b>	1085
<b>Load height in mm</b>	530
<b>Tyres in inches</b>	14
<b>Wheel shock absorbers</b>	Standard

Subject to change without notice. All dimensions are approximate values and refer to the standard vehicle without accessories.



# HU wheels-in trailer

Impressive in every respect  
thanks to its durability and quality

- 1** Welded and hot-dip galvanised chassis
- 2** Base plate, 15 mm thick
- 3** 300-mm side plates, fully foldable and removable
- 4** Drawbar closures
- 5** Conical stanchions, removable
- 6** Jockey wheel
- 7** Lighting integrated in the underrun protection
- 8** V-groove outer frame with two pairs of recessed lashing rings



## 1000 Series

Model	HU 752314	HU 132314
Overall dimension in mm	3535 x 1535 x 988	3580 x 1535 x 955
Internal dimension in mm	2300 x 1400 x 300	2300 x 1400 x 300
Total permissible weight in kg	750	1300
Load capacity in kg	520	1010
Load height in mm	690	655
Tyres in inches	13	13

Model	HU 152314
Overall dimension in mm	3580x1535x955
Internal dimension in mm	2300x1400x300
Total permissible weight in kg	1500
Load capacity in kg	1210
Load height in mm	655
Tyres in inches	13

- 1 V-groove outer frame with two pairs of recessed lashing rings
- 2 Drawbar closures
- 3 Steel lattice extension (optional)

Subject to change without notice. All dimensions are approximate values and refer to the standard vehicle without accessories.





# HU wheels-in trailer

## \*Accessories (optional):

- Flat tarpaulin
- 350 mm side plate extension
- 620-mm closed aluminium extension
- 620-mm steel lattice extension
- Tarpaulin and frame, various load heights
- Supporting feet
- Toolbox



Stanchions and side plates are completely removable! →





# HN wheels-in trailer

Tailored to special tasks  
thanks to its low loading height and high flexibility

- 1 **V drawbar**, hot-dip galvanised
- 2 **Low frame construction**
- 3 **13-pin plug** and **reversing light**
- 4 **Base plate** 18 mm thick
- 5 **Completely removable side plates** made of an **anodised, double-walled aluminium profile** with recessed fasteners
- 6 **Four lashing rings** integrated in a V-shaped outer frame profile; each hoop can withstand a tensile force of 400 kg, as tested by DEKRA
- 7 Jockey wheel
- 8 Humbaur **multifunctional lighting** integrated in the underrun protection
- 9 **Stanchions** for slotting in optional equipment



## 1000 Series

<b>Model</b>	<b>HN 132616</b>
<b>Overall dimension in mm</b>	3920x1713x930
<b>Internal dimension in mm</b>	2650x1650x300
<b>Total permissible weight in kg</b>	1300
<b>Load capacity in kg</b>	962
<b>Load height in mm</b>	610
<b>Tyres in inches</b>	13

<b>Model</b>	<b>HN 152616</b>
<b>Overall dimension in mm</b>	3920x1713x930
<b>Internal dimension in mm</b>	2650x1650x300
<b>Total permissible weight in kg</b>	1500
<b>Load capacity in kg</b>	1152
<b>Load height in mm</b>	610
<b>Tyres in inches</b>	13

- 1** Stanchion pockets and removable stanchions, both hot-dip galvanised
- 2** Lashing rings integrated directly in the outer frame (4x)
- 3** Ideal for loading from all sides

Subject to change without notice. All dimensions are approximate values and refer to the standard vehicle without accessories.

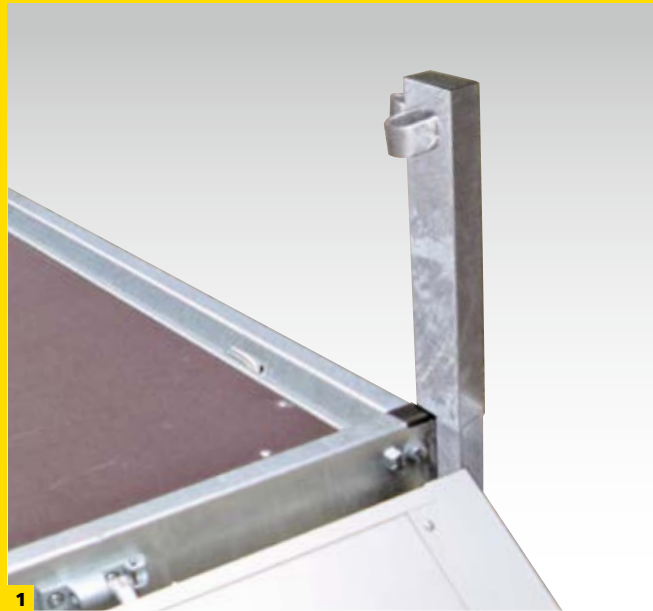

# HN wheels-in trailer



## \*Accessories (optional):

- Long drawbar
- Spare wheel
- Spare wheel bracket mounted on the drawbar (only possible on long drawbars)
- Two telescopic crank supports
- 7-pin to 13-pin adapter
- Wheel shock absorbers (loose) without 100 km/h confirmation
- Wheel shock absorbers (mounted) with 100 km/h approval
- 350-mm side plate
- 350 mm side plate extension
- H-frame
- Flat tarpaulin
- Flat tarpaulin with side plate extension
- Tarpaulin and frame, load height 1300 mm/1600 mm/1800 mm



Stanchions and side plates are completely removable!



# Optional accessories — to meet your requirements

## Body



350-mm side plate extension (300 mm on the Startrailer)



H-frame



Wood/aluminium cover for base side plate



Front gate

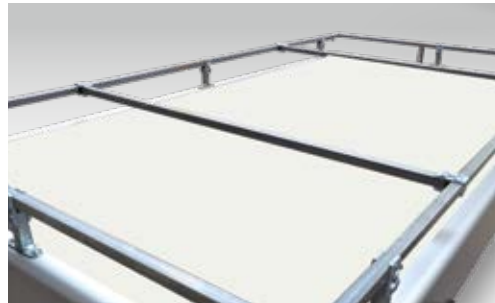

Crossbars for bicycle rails (2x, loose)



Bicycle stand rail with lockable bracket (1x)  
for wood/aluminium cover

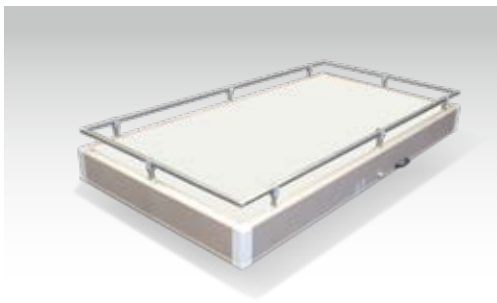

Railing on wood/aluminium cover



Side or front and rear railings



Steel lattice extension for HA models

## Lighting/electronics



7-pin to 13-pin adapter



13-pin to 7-pin adapter

## Chassis



Long drawbar (version depends on model)



Crossbar (loose) for jockey wheel

## Anti-theft device



Padlock for braked trailers up to 3500 kg (with AL-KO AE)

## Securing loads



Covering net



Wheel shock absorbers (mounted), with 100 km/h confirmation; wheel shock absorbers (loose) without 100 km/h confirmation



Prop stands (loose, 2x)



Metal locking shoe with lock



Tie rings recessed into the wooden floor; each ring can withstand a tensile force of 0.2 t (4x) or 0.4 t (4x or 6x)



Telescopic crank supports (2x)



Jockey wheel (version depends on model)



Plug lock for unbraked trailers

# Optional accessories — to meet your requirements

## Wheels



Spare wheel

## Tarpaulins



Flat tarpaulin (available in different colours depending on the model), even with the side plate extension fitted



Spare wheel bracket mounted on the drawbar (only possible on long drawbars and certain models)



Version with flat tarpaulin and side railings (incl. front and rear railings)



Spare wheel bracket (loose)



Tarpaulin and frame, load height 1000/1300/1600/1800 mm (version depends on model)

## Standard tarpaulin colours

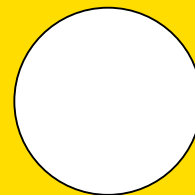

White/similar to RAL 9010

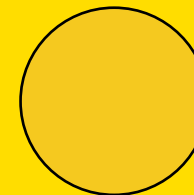

Medium Yellow/similar to RAL 1003

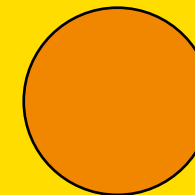

Orange/similar to RAL 2011

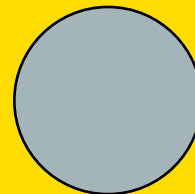

Grey/similar to RAL 7038

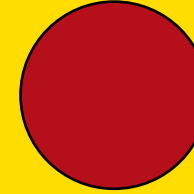

Red/similar to RAL 3002

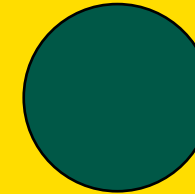

Green/similar to RAL 6026

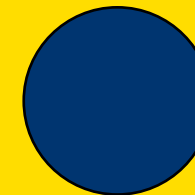

Blue/similar to RAL 5002

**We are happy to create customised lettering on tarpaulins upon request!**



Please note that the colours shown may vary from the original colours.







## "Humbaur Brand quality..."

...has been our motto since the company was established in 1957. With around 420 series-production models for the private and commercial sectors, Humbaur is now one of Europe's leading trailer manufacturers.

Innovative and experienced, with a presence throughout Europe and beyond. As an owner-managed, medium-sized family business, we know what our customers need and how they work. This is why we develop our products meticulously, manufacturing them with the greatest care and then putting them through their paces. Innovative ideas, cutting-edge manufacturing, a clear focus on quality and competent, comprehensive support are our strengths. Strengths that we employ to serve our customers.

*Ulrich Humbaur*  
*Proprietor, Director/CEO*



## Take a look at our product range...

We offer a large variety of trailer models. Have a look at our brochures for our **single/tandem-axle trailers**, our **vehicle, horse, animal and universal transport trailers**, our **construction and flatbed trailers**, our **freight trailers and our box bodies**. We will gladly customise a trailer to meet your needs. Please contact us to discuss your requirements.



**MAKES IT HAPPEN**

Your Humbaaur-Retailer:

Safety information: The trailer may only be used with express adherence to all road traffic, professional association and load securing regulations. We assume no responsibility for printing or other errors or omissions. Subject to change without notice. All dimensions are approximate values and refer to the standard vehicle without accessories. Printed in Germany. Reprinting prohibited. Illustrations are similar, some trailers and close-ups show special equipment - Order No. 009.00066 - As at: 09/19.

